



# 用户使用说明书

## User's Instruction Manual

# SHOGUN



**1:8 Scale 4WD Monster Truck**  
**MODEL#: 8385**

## Introduction

Thank you for choosing DHK's Shogun! This model is designed in thorough research and assembled with utmost craftsmanship. This high performance 1:8 scale 4WD brushed monster truck can run very fast. It is easy to drive and it uses quality parts to achieve its best performance. With proper and regular maintenance, you will enjoy a lot of fun and joy when you drive this R/C kit.

Before you drive this model, kindly take some time to read through this instruction manual for a better and safer operation. This instruction aims to provide a general guideline for end-users. Kindly note that a good understanding of the model, its relevant parts and other accessories packed in the consumer box will enable you to have fun when driving. Meanwhile, users are recommended to conduct regular maintenance for high performance and durability. Failure to do so might shorten the lifespan of the model. If you come across any problems or need any support, please contact us. We will always be very happy to assist you.

Before you operate this R/C kit, kindly make sure that you understand the following.

1. Make sure that all screws and nuts are tightened securely.
2. Make sure that the battery(ies) are fresh or fully charged so the model won't lose control.
3. Do not drive the model in the following places/areas to avoid injury of people and damage to the public property.
  - i. On public streets or in parks, causing injury or death of pedestrians, young children, animals and pets.
  - ii. On highways, leading to accidents or damage of the model.
  - iii. In water, resulting in damage to electronic components and parts, or direct failure of the model.

Drive your model in open areas.

4. Check all signals and electronic parts are working properly.

After driving, battery(ies), ESC, and motor can be very hot. Please do not touch them with bare hands.



### **Warning:**

This high performance R/C kit can run very fast. It is designed and produced for people of 14+ years of age to operate. Players under this age should be guided by adult supervision. Entry level players should seek guidance and supervision from experienced model players. Players are responsible for any/all accidental occurrences (human or animal injury, damage to property and possessions, breakage of the model itself) due to improper operation of this model.

## Model Specifications

Overall length:	19.5" (497mm)(including rear wing)
Width:	15.3" (389mm)
Height:	7.1" (181mm) (including rear wing, body not included)
Wheelbase:	12.9" (330mm)
Ground clearance:	1.96" (49.8mm)
Front track/rear track:	12.1" (306mm)/12.3" (313mm)
Tire diameter/width:	Φ6.2"/3.7" (Φ158/95mm)
Wheel diameter/width:	Φ3.5"/2.6" (Φ88/66mm)
Gear ratio:	12.33:1

## Radio System

A 2-channel radio system is required for this model. This includes 2.4GHz transmitter and receiver. Please refer to 2.4GHz Transmitter Manual.

## Battery and ESC information

This monster truck comes with a 9-cell 10.8V 3000mAh SC type NiMh battery. The battery is with T-connector, so does the battery charger. Besides, the ESC also has a T-connector to match it on the battery.

Below you may find the features and specifications of the high voltage ESC for your Shogun.

## High Voltage ESC (Part# H126)

### Features

1. Auto search throttle neutral point.
2. HF drive system
3. Over-heat protection (90C°)
4. Lipo battery low-voltage protection (2S Lipo-6.6V cutoff, 3S Lipo-9.9V shut down)
5. Low internal resistance & big capacity PCB board, providing great resistance to high current.
6. Forward, brake and reverse functions, good for both vehicles and boats.

### Specifications

Forward current:	380A
Reverse current:	190A
Brake current:	250A
Voltage range:	4.8V-12.6V
PWM frequency:	1.5KHz
BEC voltage:	5V/2A

### Operation

To obtain forward, brake and reverse functions and to switch battery types, kindly refer to the following Skipping Needles Matrix for detail. This matrix provides clear information for operation.

## Skipping Needles Matrix

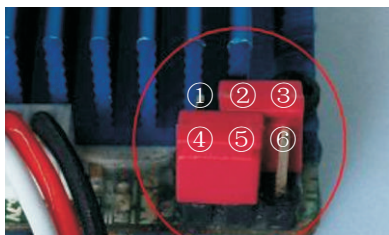

### Needles placement and corresponding functions

Needles	Functions
1, 2	Forward, brake, reverse
2, 3	Forward, brake, no reverse
4, 5	Lipo battery
5, 6	NiMh battery

### 755 brushed motor parameters

Constant voltage: 12.0V    Direction: CCW

At no load	Electrical Characteristics	Mechanical Features
Speed: 20000 RPM±10%	Rated Current: 18.0AMPS MAX	Shaft end play: 0.05-0.6mm
Current: 3.50 AMPS	Rated Speed: 17000rpm ±10%	Shaft Extension: 16.0±0.6mm
	Starting Voltage: 1.5V DC max	
	Rate Load: 660.0 g.cm	

### 9kgs Servo

Features:	Metal gears, ball bearings
Working voltage:	6.0V
Speed (seconds/60C°):	0.16sec
Torque:	9kg/cm (88.3Ncm)
Net weight:	60g
Size(LxWxH):	55x21x43mm

# Parts List

Part#	Description
8133-100	Assembly of diff gear box
8133-101	Diff set
8381-102	Diff outdrive/pins (Φ2*10mm)
8381-103	Pins(Φ2*10mm) (16 pcs)
8381-104	Flathead screw-coarse thread (KB2.6*10mm) (16 pcs)
8133-102	Crown gear-41T (large)/pinion gear-11T (small)
8381-106	Diff case set/diff case cover/diff gasket
8381-107	Washer-A/washer-B (8 pcs each)
8381-108	Gear-18T (2 pcs)/gear-12T (4 pcs)
8381-109	O Ring(Φ8mm*Φ2mm) (16 pcs)
8381-110	Ball bearing(Φ10mm*Φ15*4mm) (2 pcs)
8381-111	Diff pins(Φ4*25.8mm) (4 pcs)
8133-103	Assembly of the pinion gear
8381-113	Flathead screw(KM2.6X6mm) (16 pcs)
8381-114	Ball bearing(Φ8mm*Φ14*4mm) (2 pcs)
8381-115	Pins(Φ2*8mm) (16 pcs)
8381-116	Pinion gear outdrive/pins(Φ2*8mm)
8381-117	Ball bearing(Φ5mm*Φ11*4mm) (2 pcs)
8381-118	Diff gear box-F/R
8381-119	B head screw-coarse thread (BB3*16mm) (16 pcs)
8381-200	Central diff gear box(complete)
8381-201	Central diff set
8381-203	Spur gear-43T(plastic) (2 pcs)
8381-204	Set screws (M4*4mm) (16 pcs)
8381-206	Center diff gear box/center diff gear box plate
8381-208	Center outdrive set

Part#	Description
8136-300	Shock absorber complete (2 pcs)
8381-305	Shock ball (8 pcs)
8381-306	M3 nylon nut (8 pcs)
8381-309	Shock shaft (4 pcs)
8136-302	Shock spring (4 pcs)
8381-50L	Assembly of upper sus.arm-left
8381-50R	Assembly of upper sus.arm-right
8381-501	Upper sus.arm ball (4 pcs)
8381-502	Upper sus.arm/rod end (2 sets)
8381-503	Upper sus.arm linkage (2 pcs)
8135-600	Servo saver assembly-complete
8135-601	Steering plate
8381-601	Brass washer (4 pcs)
8381-602	Servo saver bushing/adjustment ring
8381-603	Servo saver spring (4 pcs)
8381-604	Servo saver sus. Arm-upper/lower/steering sus. Arm
8381-605	B head screw-coarse thread (BB3*12mm) (16 pcs)
8381-606	Screw bushing (16 pcs)
8381-608	Shaft (2 pcs)
8381-6Z0	Assembly of steering linkage (2 pcs)
8381-6Z1	Steering linkage (2 pcs)
8381-6Z2	Plastic rod end (8 pcs)
8381-6Z3	Double way ball end (8 pcs)
8381-701	Upper sus.arm mount-rear/suspension mount
8381-702	B head screw-coarse thread (BB3*14mm) (16 pcs)
8381-703	B head screw-coarse thread (BB3*10mm) (16 pcs)
8381-706	Lower sus.arm-front (2 pcs)
8381-707	Drive shaft set/revolving shaft (2 sets)

# Parts List

Part#	Description
8381-708	Wheel axle (2 pcs)
8381-710	Ball bearing( $\Phi$ 6mm* $\Phi$ 12*4mm) (2 pcs)
8381-714	C-hub (2 pcs)
8381-717	Shock tower (2 pcs)
8381-718	Pivot ball mount (4 pcs)
8381-719	Upper sus.arm shaft (4 pcs)
8381-721	Lower sus.arm plate-front
8381-723	C-hub screw bushings (16 pcs)
8381-724	T head hex screws (TM4*12mm) (16 pcs)
8381-725	T head hex screws (TM4*22mm) (16 pcs)
8381-726	B head screw-coarse thread (BB3*18mm) (16 pcs)
8381-727	B head screw(BM3*56mm) (8 pcs)
8381-728	B head screw(BM3*43mm) (8 pcs)
8382-702	Bumper/upper sus.arm mount-front
8382-703	Body post holder/body post
8382-705	B head screw (BM3*24mm) (16 pcs)
8382-706	Wheels-1/8 Maximus/Zombie (2 pcs)
8135-702	Steering arm (2 pcs)
8384-701	Hex adapter/M12 17mm nut
8381-801	Lower sus.arm-rear (2 pcs)
8381-802	Rear hub-L/R
8381-803	B head screw(BM3*18mm) (16 pcs)
8381-804	Wing mount/wing brace-L/R
8381-805	B head screw(BM3*10mm) (16 pcs)
8381-806	Rear wing rod-long/short
8381-807	Pin-A( $\Phi$ 1.5mm) (16 pcs)
8385-9M1	Motor mount

Part#	Description
8385-9M2	Motor gear-13T/set screw (M4*4)
8385-9M3	B head screw(BM4*10mm) (16 pcs)
8381-9S1	Servo mount
9381-9S4	Servo arm-C (2 pcs)
8381-9S5	B head screw(BM2.6*6mm) (12 pcs)
8381-9Z0	Assembly of steering tie rod
8381-9Z1	Steering tie rod (2 pcs)
8135-002	Chassis
8135-004	Upper deck mount-F/R
8135-005	Battery mount-C/D
8383-002	Rear wing (black)
8384-001	Tire complete (2 pcs)
8384-004	Tires with wheel (Unglued) (2 pcs/set)
8385-001	Printed body (PC) with body decals
8385-002	Clear body (PC),with window cutout and decals
8385-003	Screw washer-M4 (4 pcs)
8385-004	Flathead screw(KM4X10mm) (16 pcs)
8331-003	Body foam( $\phi$ 18* $\phi$ 8*2) (4pcs)
8381-005	Central drive shaft-A
8381-006	Central drive shaft-B
8381-007	Receiver cover-upper/lower
8381-008	Antenna tube (3pcs)
8381-009	Pin-B( $\Phi$ 1.2mm) (16 pcs)
8381-012	Flathead screw-coarse thread (KB3*10mm) (16 pcs)
8381-016	Upper deck-A
8381-017	Upper deck-B
8381-022	17mm nut (4 pcs/set)
8381-024	Flathead screw(KB4*11.5mm) (12 pcs)

# Parts List

---

---

Part#	Description
H126	High Voltage ESC
H127	775 Motor
H128	10.8V SC 3000mAh NiMh battery
H129	9-cell NiMh battery charger, 12.6V 1000mAh output
D301	Servo (9kg metal gears)
D302T	2.4GHz transmitter
D302S	2.4GHz receiver

## Optional parts

8381-400	Anti-roll bar assembly
8381-40L	Assembly of anti-roll bar linkage-left
8381-40R	Assembly of anti-roll bar linkage-right
8381-401	Anti-roll bar rod end (8 pcs)
8381-402	Anti-roll bar linkage (4 pcs)
8381-403	Anti-roll bar pivot ball-upper/lower (4 sets)
8381-404	Set screws (M3*3mm) (8 pcs)
8381-405	Anti-roll bar(dia 2.2mm) (2 pcs)
8381-607	Steering plate
8381-709	Steering arm (2 pcs)
8381-716	Set screws (M4*10mm) (16 pcs)
D302HT	2.4GHz LCD transmitter

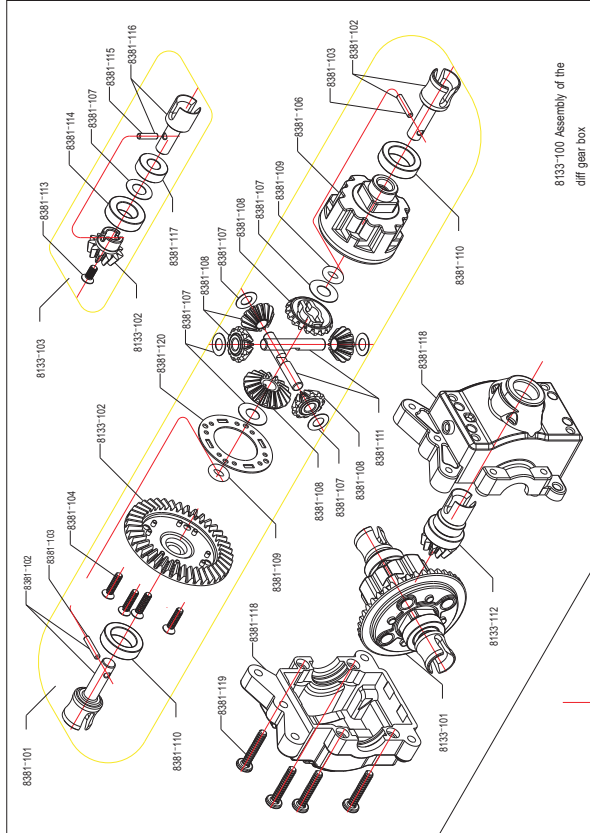

8133-100 Assembly of the diff gear box

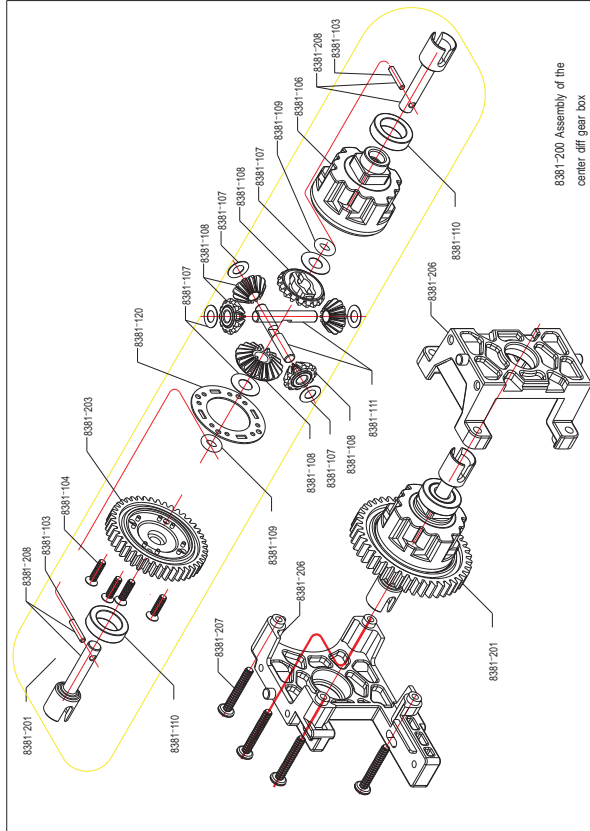

8381-200 Assembly of the center diff gear box

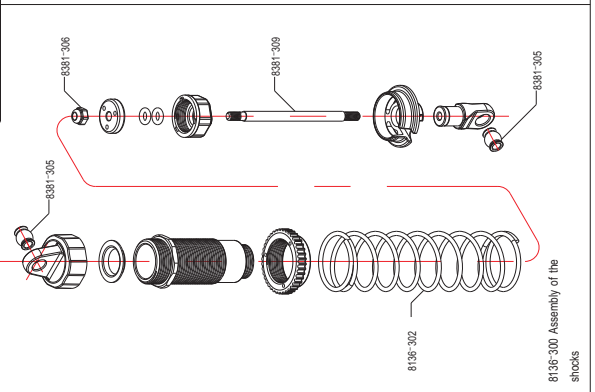

8136-300 Assembly of the shocks

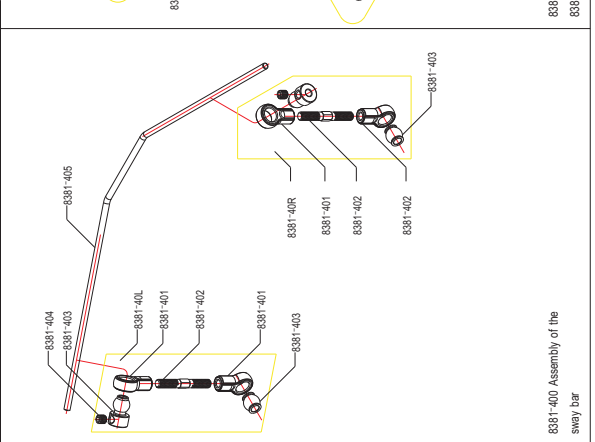

8381-400 Assembly of the sway bar

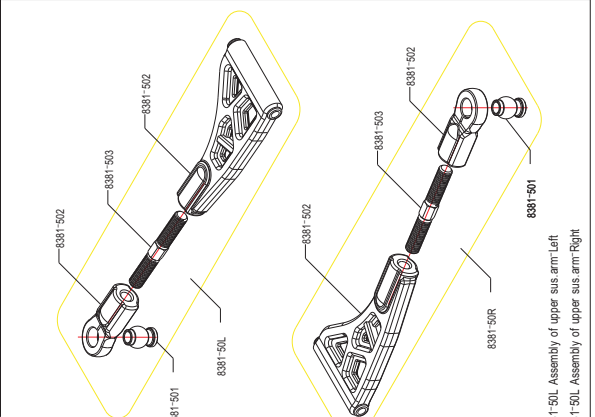

8381-50L Assembly of upper sus arm Left  
8381-50R Assembly of upper sus arm Right

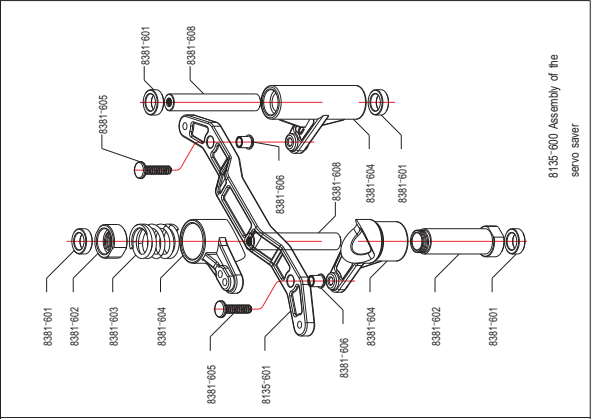

8135-600 Assembly of the servo saver





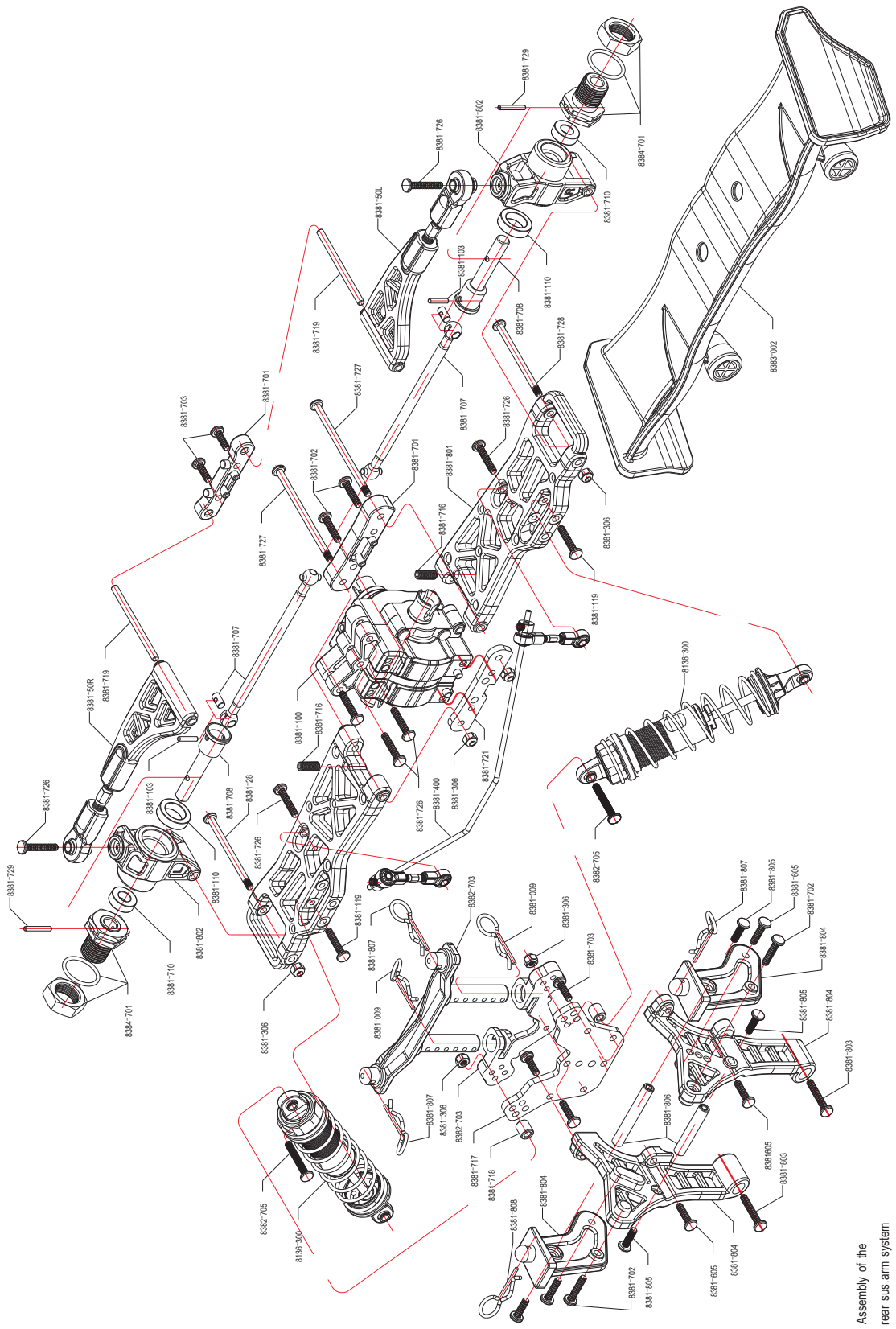

Assembly of the rear sus. arm system



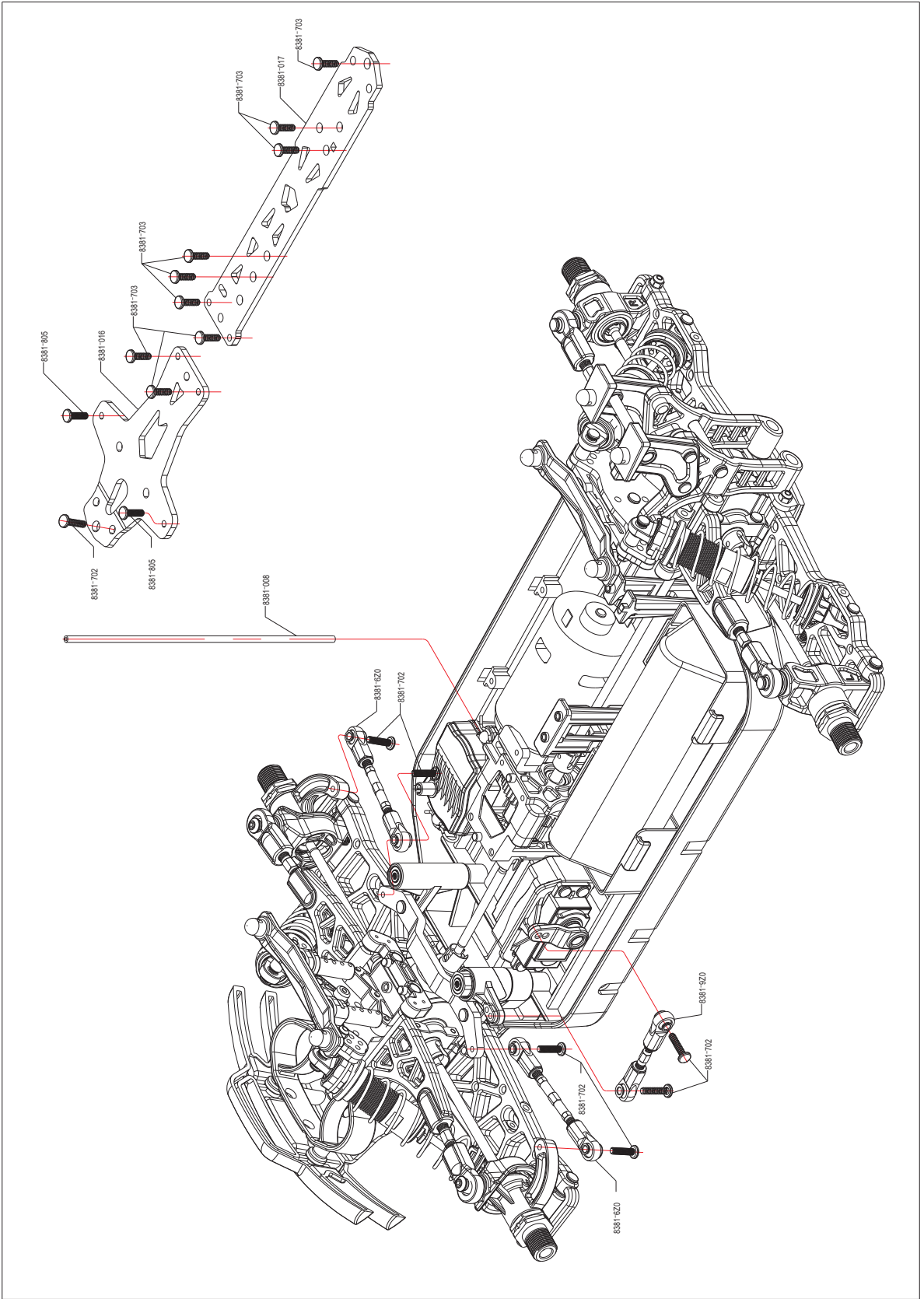

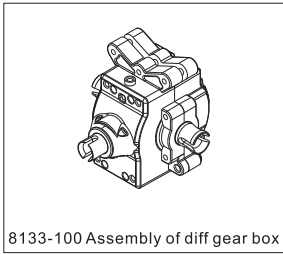

8133-100 Assembly of diff gear box

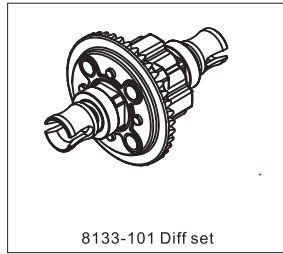

8133-101 Diff set

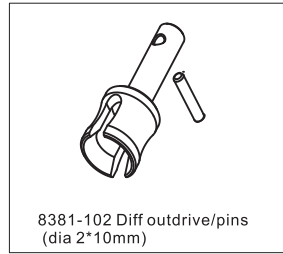

8381-102 Diff outdrive/pins  
(dia 2\*10mm)

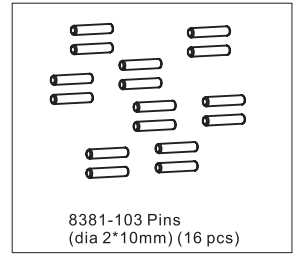

8381-103 Pins  
(dia 2\*10mm) (16 pcs)

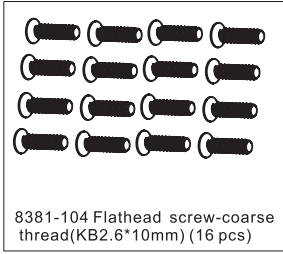

8381-104 Flathead screw-coarse  
thread(KB2.6\*10mm) (16 pcs)

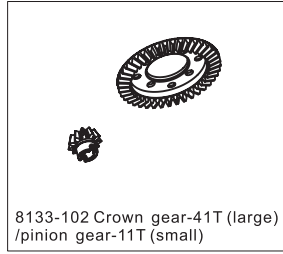

8133-102 Crown gear-41T (large)  
/pinion gear-11T (small)

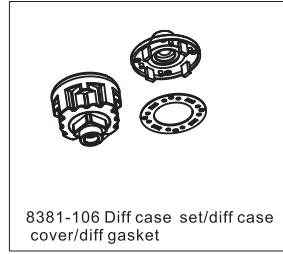

8381-106 Diff case set/diff case  
cover/diff gasket

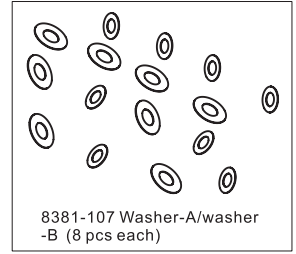

8381-107 Washer-A/washer  
-B (8 pcs each)

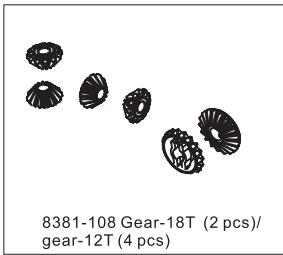

8381-108 Gear-18T (2 pcs)/  
gear-12T (4 pcs)

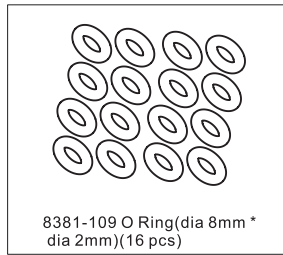

8381-109 O Ring(dia 8mm \*  
dia 2mm)(16 pcs)

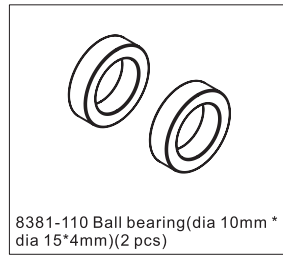

8381-110 Ball bearing(dia 10mm \*  
dia 15\*4mm)(2 pcs)

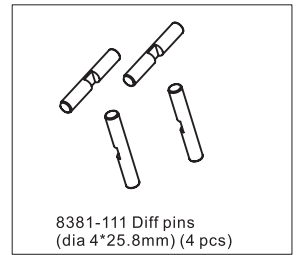

8381-111 Diff pins  
(dia 4\*25.8mm) (4 pcs)

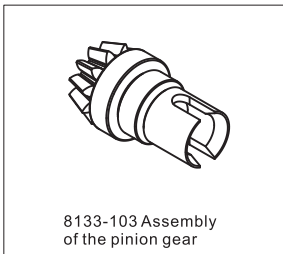

8133-103 Assembly  
of the pinion gear

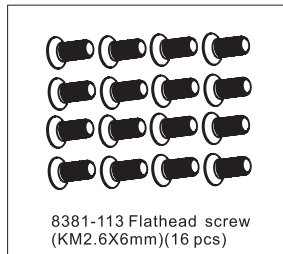

8381-113 Flathead screw  
(KM2.6X6mm)(16 pcs)

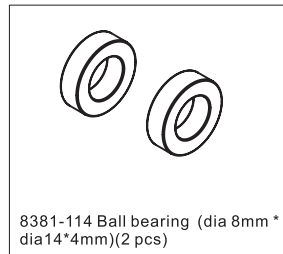

8381-114 Ball bearing (dia 8mm \*  
dia 14\*4mm)(2 pcs)

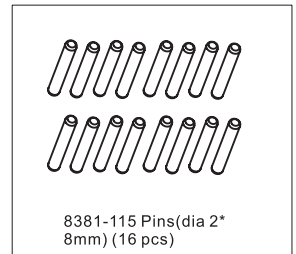

8381-115 Pins(dia 2\*  
8mm) (16 pcs)

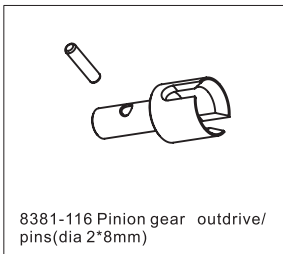

8381-116 Pinion gear outdrive/  
pins(dia 2\*8mm)

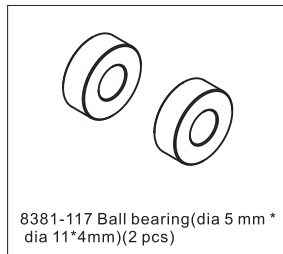

8381-117 Ball bearing(dia 5 mm \*  
dia 11\*4mm)(2 pcs)

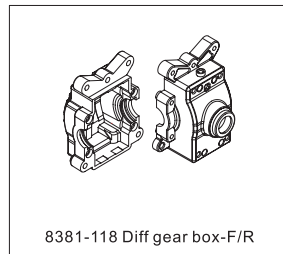

8381-118 Diff gear box-F/R

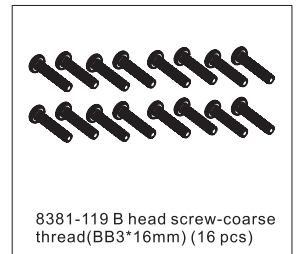

8381-119 B head screw-coarse  
thread(BB3\*16mm) (16 pcs)

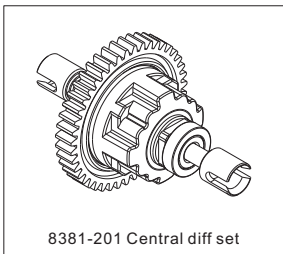

8381-201 Central diff set

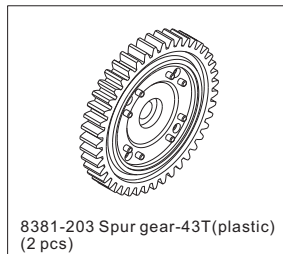

8381-203 Spur gear-43T(plastic)  
(2 pcs)

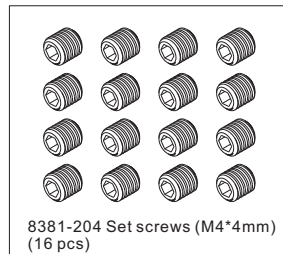

8381-204 Set screws (M4\*4mm)  
(16 pcs)

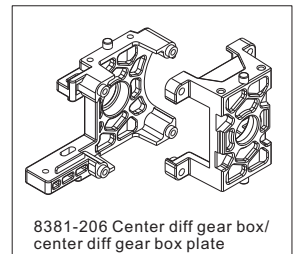

8381-206 Center diff gear box/  
center diff gear box plate

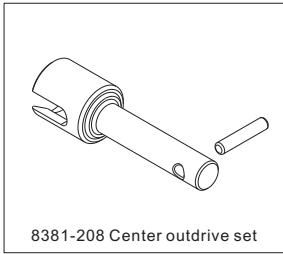

8381-208 Center outdrive set

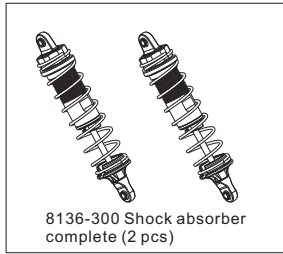

8136-300 Shock absorber complete (2 pcs)

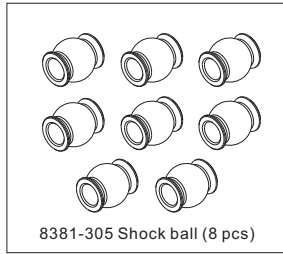

8381-305 Shock ball (8 pcs)

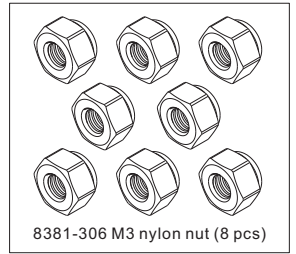

8381-306 M3 nylon nut (8 pcs)

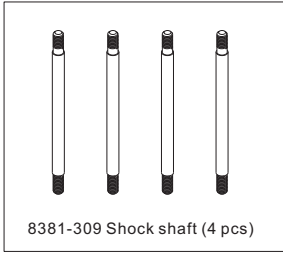

8381-309 Shock shaft (4 pcs)

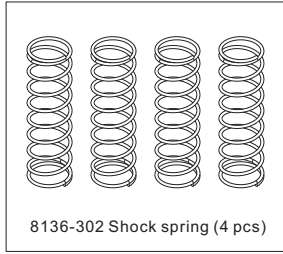

8136-302 Shock spring (4 pcs)

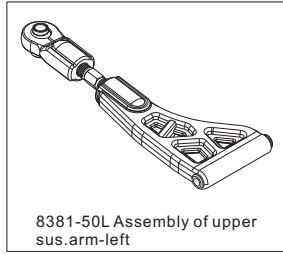

8381-50L Assembly of upper sus.arm-left

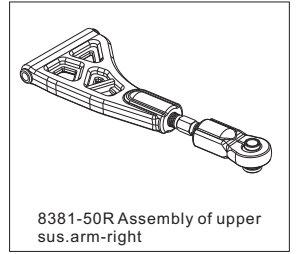

8381-50R Assembly of upper sus.arm-right

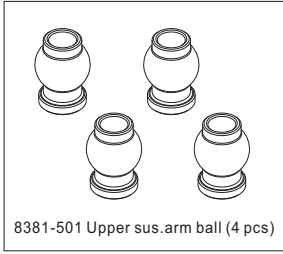

8381-501 Upper sus.arm ball (4 pcs)

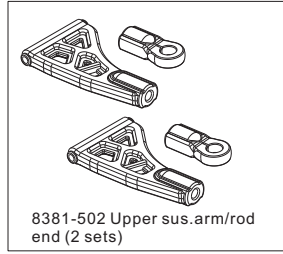

8381-502 Upper sus.arm/rod end (2 sets)

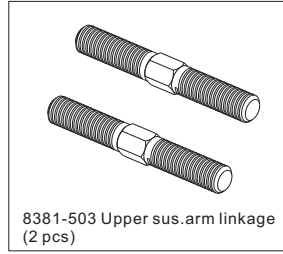

8381-503 Upper sus.arm linkage (2 pcs)

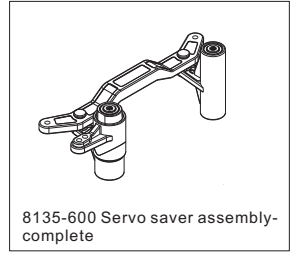

8135-600 Servo saver assembly-complete

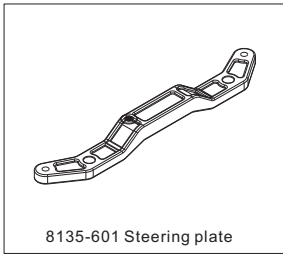

8135-601 Steering plate

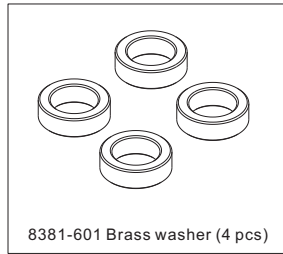

8381-601 Brass washer (4 pcs)

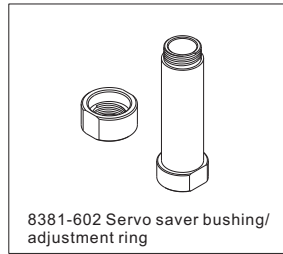

8381-602 Servo saver bushing/adjustment ring

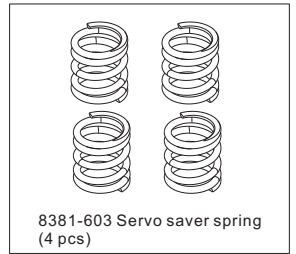

8381-603 Servo saver spring (4 pcs)

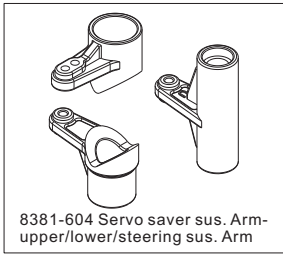

8381-604 Servo saver sus. Arm-upper/lower/steering sus. Arm

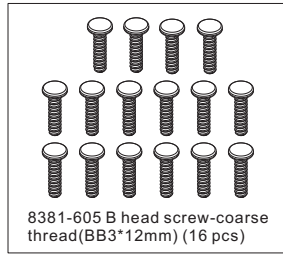

8381-605 B head screw-coarse thread(BB\*12mm) (16 pcs)

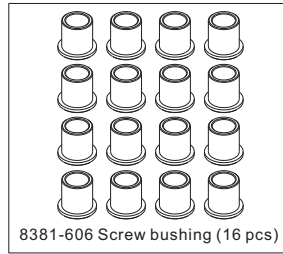

8381-606 Screw bushing (16 pcs)

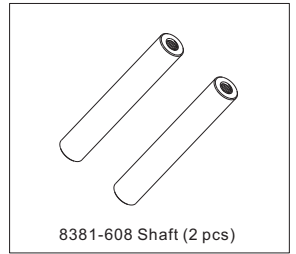

8381-608 Shaft (2 pcs)

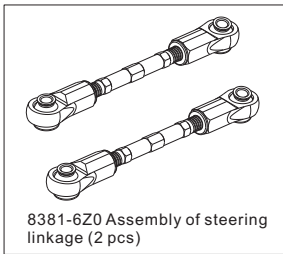

8381-6Z0 Assembly of steering linkage (2 pcs)

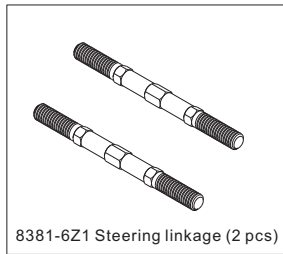

8381-6Z1 Steering linkage (2 pcs)

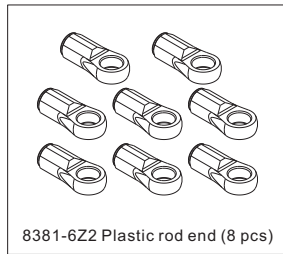

8381-6Z2 Plastic rod end (8 pcs)

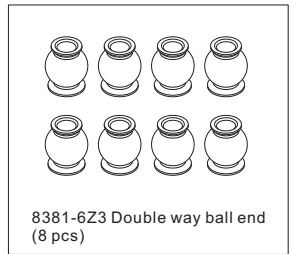

8381-6Z3 Double way ball end (8 pcs)

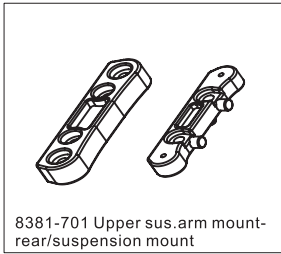

8381-701 Upper sus. arm mount-rear/suspension mount

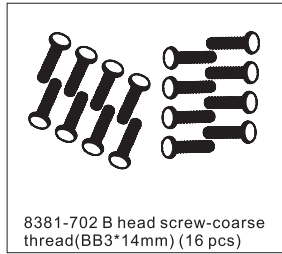

8381-702 B head screw-coarse thread(BB3\*14mm) (16 pcs)

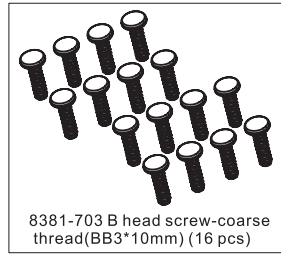

8381-703 B head screw-coarse thread(BB3\*10mm) (16 pcs)

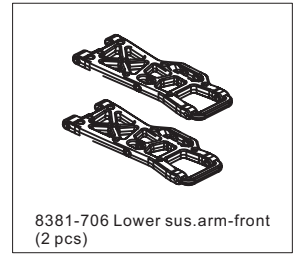

8381-706 Lower sus. arm-front (2 pcs)

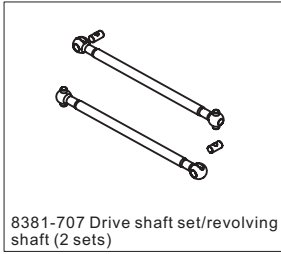

8381-707 Drive shaft set/revolving shaft (2 sets)

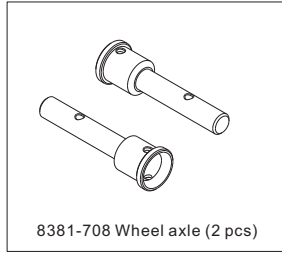

8381-708 Wheel axle (2 pcs)

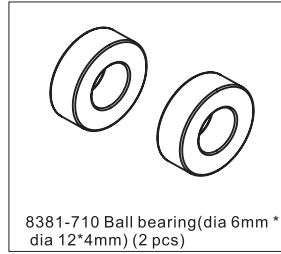

8381-710 Ball bearing(dia 6mm \* dia 12\*4mm) (2 pcs)

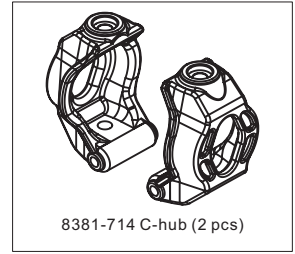

8381-714 C-hub (2 pcs)

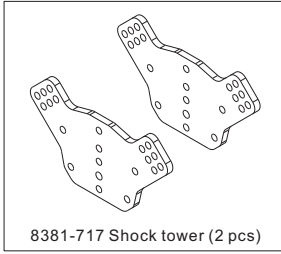

8381-717 Shock tower (2 pcs)

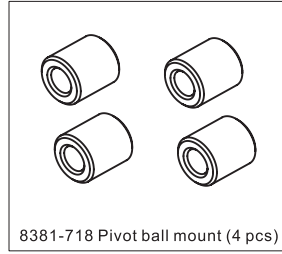

8381-718 Pivot ball mount (4 pcs)

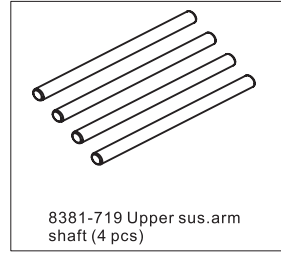

8381-719 Upper sus. arm shaft (4 pcs)

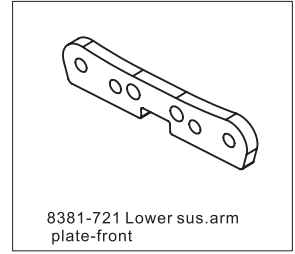

8381-721 Lower sus. arm plate-front

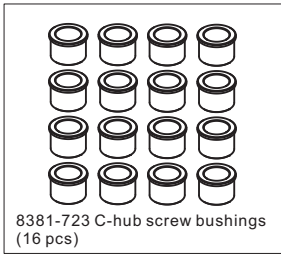

8381-723 C-hub screw bushings (16 pcs)

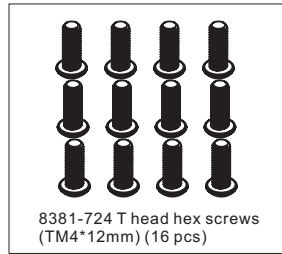

8381-724 T head hex screws (TM4\*12mm) (16 pcs)

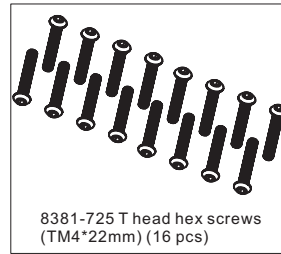

8381-725 T head hex screws (TM4\*22mm) (16 pcs)

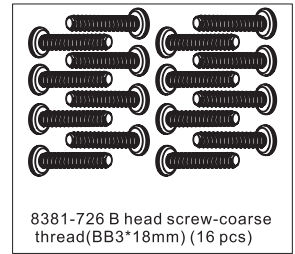

8381-726 B head screw-coarse thread(BB3\*18mm) (16 pcs)

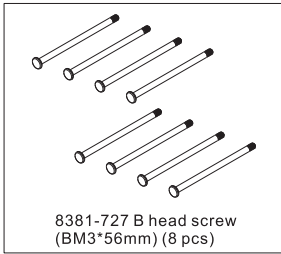

8381-727 B head screw (BM3\*56mm) (8 pcs)

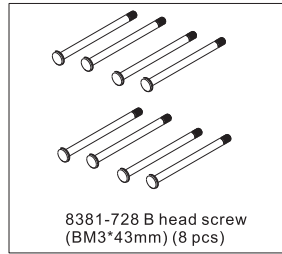

8381-728 B head screw (BM3\*43mm) (8 pcs)

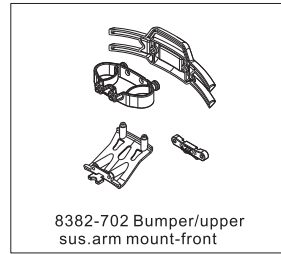

8382-702 Bumper/upper sus. arm mount-front

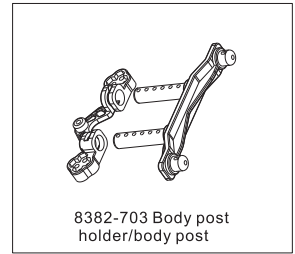

8382-703 Body post holder/body post



8382-705 B head screw (BM3\*24mm) (16 pcs)



8382-706 Wheels-1/8 Maximus/Zombie (2 pcs)

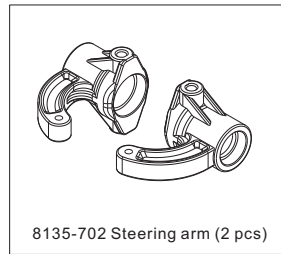

8135-702 Steering arm (2 pcs)



8384-701 Hex adapter/M12 17mm nut

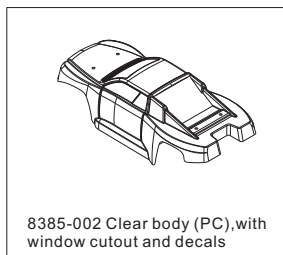
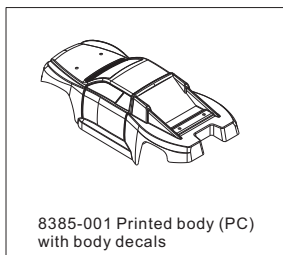
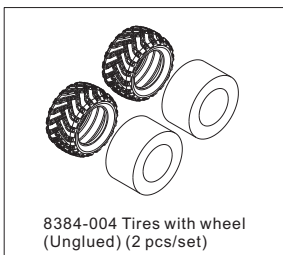
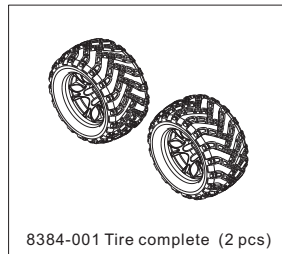
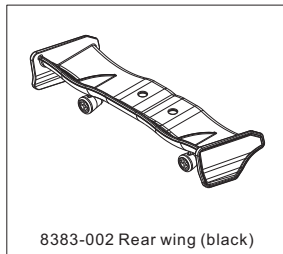
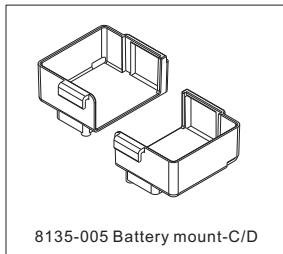
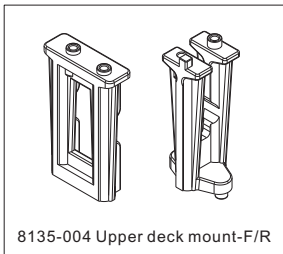
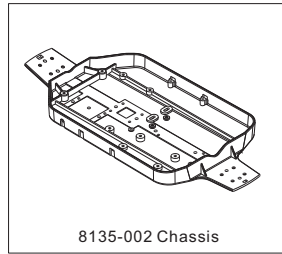
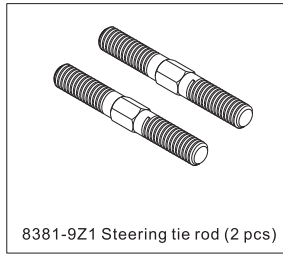
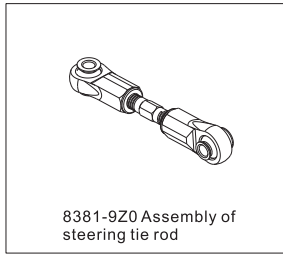
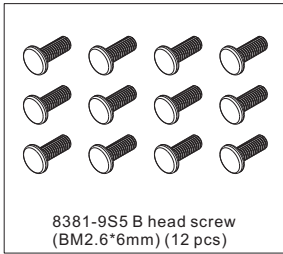
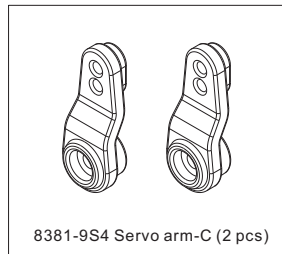
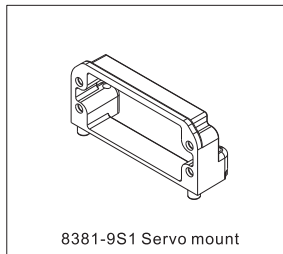
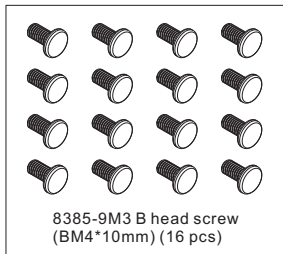
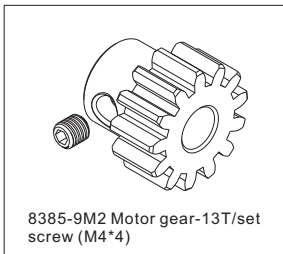
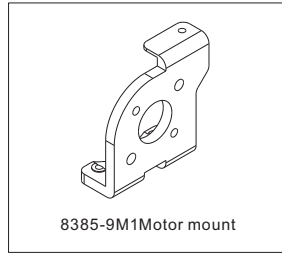
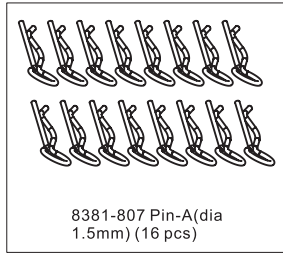
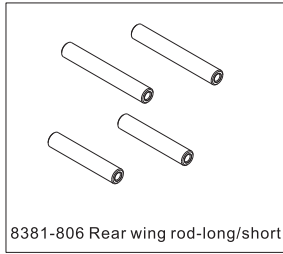
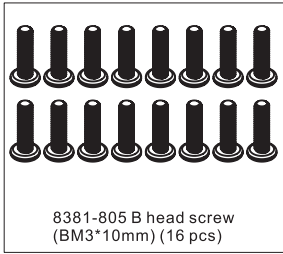
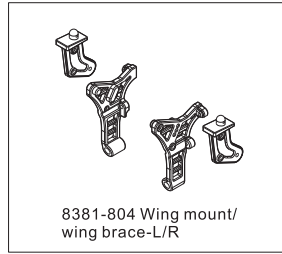
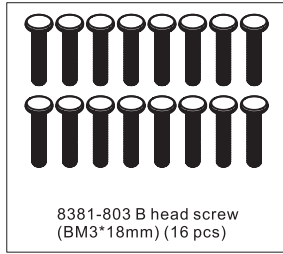
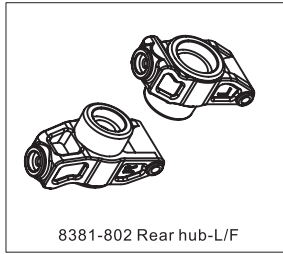
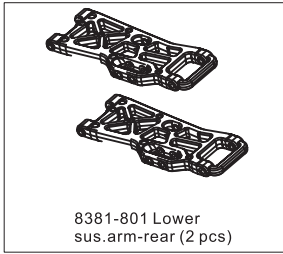



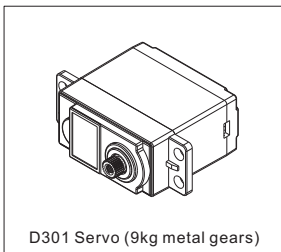
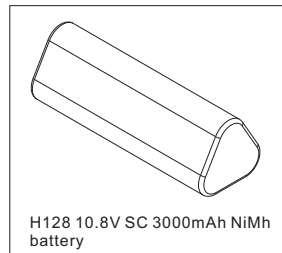
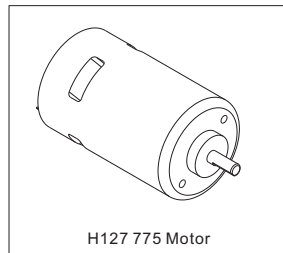
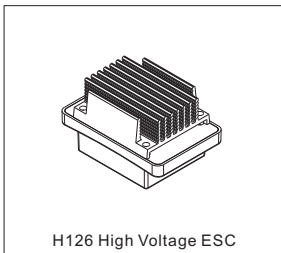
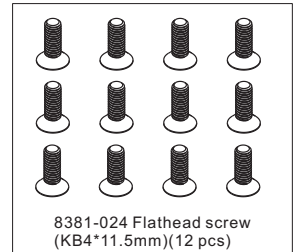
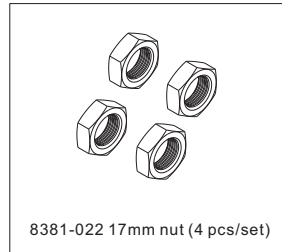
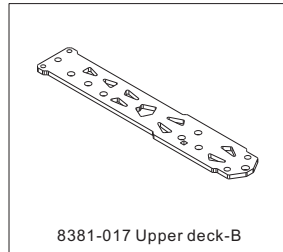
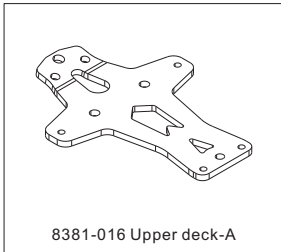
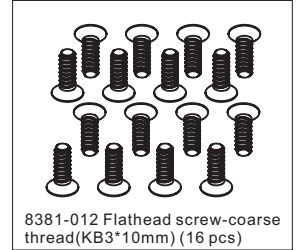
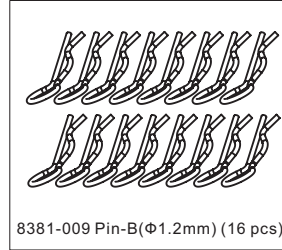
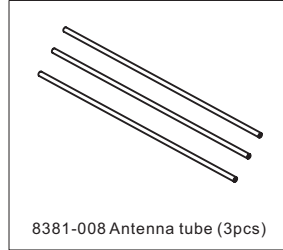
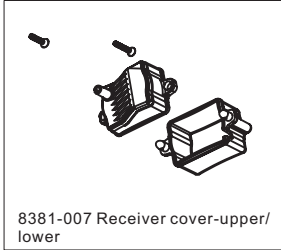
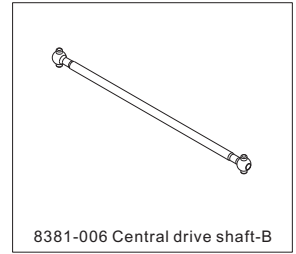
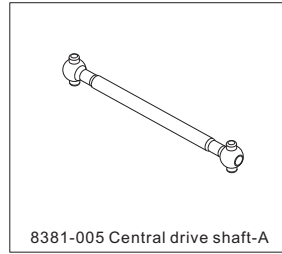
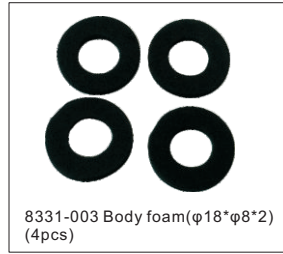
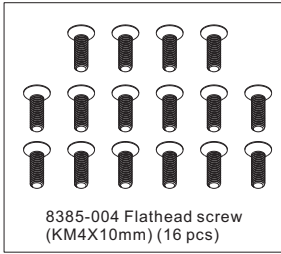

**Optional parts**

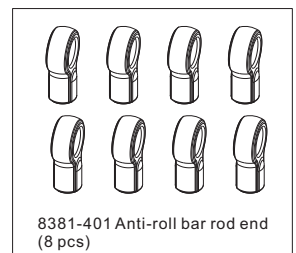
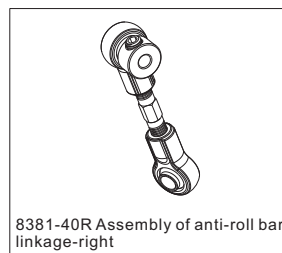
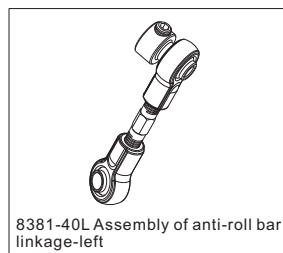
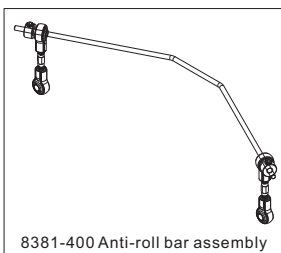

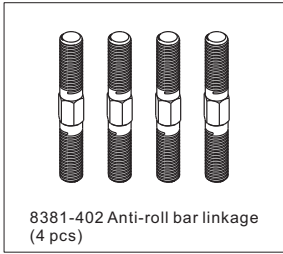

8381-402 Anti-roll bar linkage  
(4 pcs)

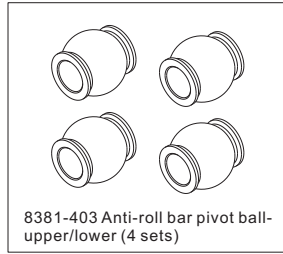

8381-403 Anti-roll bar pivot ball-  
upper/lower (4 sets)

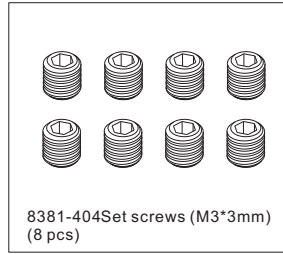

8381-404 Set screws (M3\*3mm)  
(8 pcs)

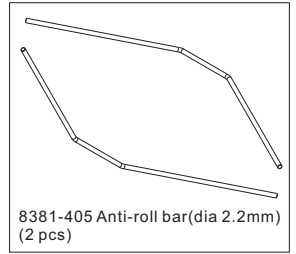

8381-405 Anti-roll bar (dia 2.2mm)  
(2 pcs)

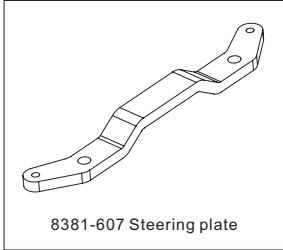

8381-607 Steering plate

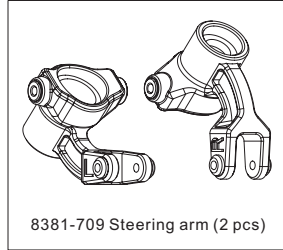

8381-709 Steering arm (2 pcs)



8381-716 Set screws (M4\*10mm)  
(16 pcs)



D302HT 2.4GHz LCD transmitter

# Annex: 2.4GHz Transmitter Manual

## PART I:

### 2.4GHz Transmitter (Standard, Model#: D302T)

#### Safety Precautions

1. The 2.4GHz transmitter and receiver are pre-bound at the factory.
2. Please always use the same receiver model from the factory to match your 2.4GHz transmitter when you need to replace it. Receivers from other suppliers don't work on DHK HOBBY 2.4GHz transmitter.
3. When you need to replace a receiver, please make sure that it is bound with the transmitter before use.
4. Please operate the transmitter in vast areas where no radio interference exists. It's strongly recommended that no humans, animals or high voltage grid should be nearby.
5. Please do not operate this transmitter during fatigue, sickness, intoxication or in bad mood.
6. Do not operate the transmitter at night time, in the rain and thunderstorm or at low visibility.
7. Always use the same types of batteries in the transmitter. Do not mix old and new batteries in the transmitter. Please check the battery power before use. Replace batteries whenever the power is low to avoid out of control.
8. Before you operate the transmitter, please check the switch, batteries, servo and ESC for proper connection.
9. ALWAYS switch on the transmitter first, and off last so as to avoid possible radio interference from other sources. Failure to do so may cause out of control of your vehicle.
10. Before operation, check the servo forward and reverse functions, motor range, and neutral position. Modify it when necessary.
11. Please handle the transmitter with care. Store the transmitter in a dry and clean place when it's not in use for some time.

#### Transmitter Specifications

Channels	2 channels
Model types	Cars, boats
Frequency range	2.40-2.483GHz
RF power	≤20dB
Power output	10mW
Bandwidth	1M
Band number	64
2.4GHz modulation	AFHDS
Encoding	GFSK

Channel resolution	4096
Remote range	>200M
TH range	0.9mS-2.1mS
ST range	0.9mS-2.1mS
Battery voltage	6V (1.5V*4 cells)
Low voltage protection	≤4.4V
Weight	320g
USB port	N/A
Charging port	Yes

#### 2.4GHz Standard Transmitter Parts and Functions

- 1-Antenna: pull up the antenna straight before use.
- 2-Power switch: slide the switch to turn on or off.
- 3-Power LED: shows the power strength. Green LED shows full power, Yellow LED flashes when the power is running short.
- 4-Charging port: charges Ni-Mh or Ni-Cd batteries only. Alkaline batteries are not rechargeable. NEVER charge your alkaline batteries.
- 5-Throttle trigger: Please refer to the transmitter diagram.
- 6-Steering wheel: Please refer to the transmitter diagram.
- 7-ST-D/R trim: adjust the steering servo angle ranging from 0% to 120%.
- 8-TH-D/R trim: adjust the throttle servo angle ranging from 0% to 120%.
- 9-ST-TRIM: adjust the steering neutral position, from 0% to 20%.
- 10-TH-TRIM: adjust the throttle neutral position, from 0% to 20%.
- 11-ST-NOR/REV: slide to left or right to choose steering mode.

12-TH-NOR/REV: push the trigger or pull it back to choose the throttle mode.

13-Throttle trigger trim screws: use a hex driver to tighten or loosen the screw to a comfortable level.

14-Battery compartment cover: to open the compartment, slide the cover to OPEN direction as indicated, snap it to close the compartment.

15-Battery case: open the battery cover, install 4 pcs AA 1.5V alkaline or rechargeable batteries based on the "+" & "-" poles. If the status LED flashes red, the transmitter batteries may be weak, discharged or possibly installed incorrectly. Replace with new or freshly charged batteries. The power indicator light does not indicate the charge level of the battery pack installed in the model.

## Parts Diagrams

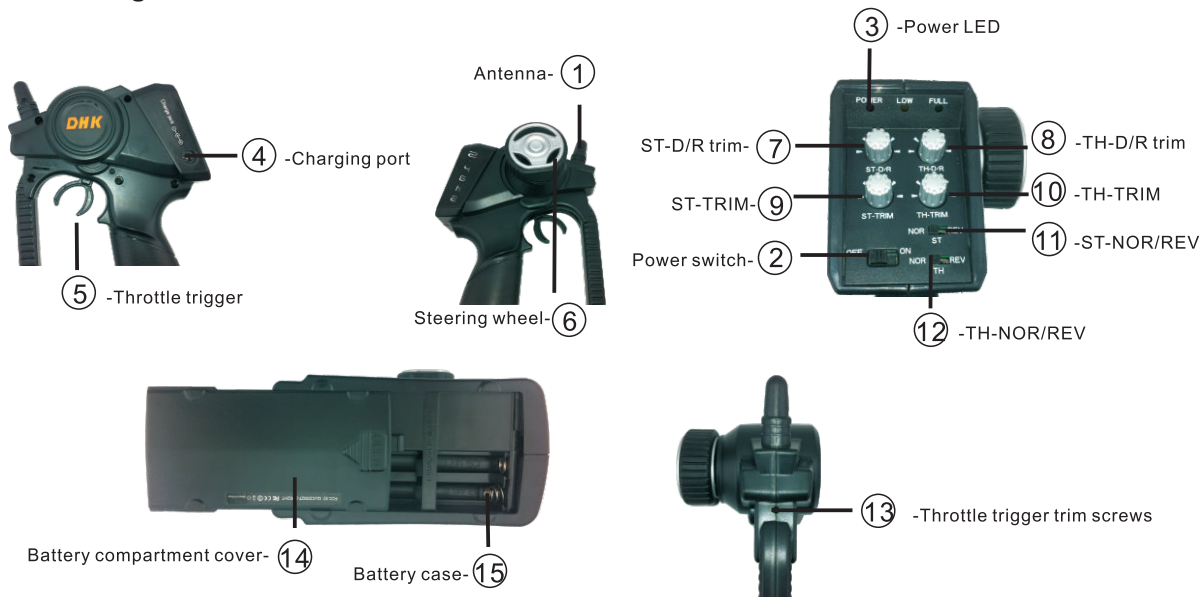

## Receiver Functions

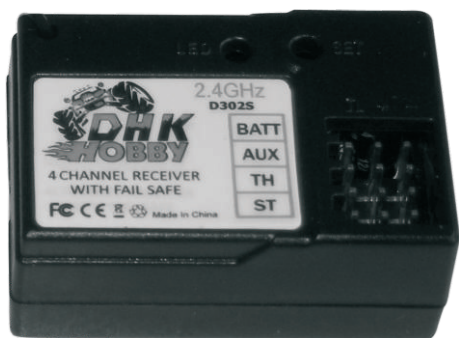

Frequency range	: 2.4GHz
2.4GHz modulation	: AFHDS
Sensitivity	: -100dbm
Working voltage	: DC4.8-6.0V
Working current	: ≤25mA
Size	: 5.7*26*15.2mm
Weight	: 11.2g

**1. Antenna:** Pull out the antenna completely

**2. Connecting ports:** receiver power port and channel signal connecting ports

> ST/1: Channel 1, steering signal port

> TH/2: Channel 2, throttle servo or ESC signal port

> AUX/3: Auxiliary signal port

> BATT/4: Receiver power port, can be auxiliary signal port

**3. Set keys & LED indicators**

>**Bind setup.** Switch on the receiver, indicators flash slowly, press the setup key for 2 seconds and release it, LED indicator flash in faster motion, binding starts. When the LED indicator is on in stable status, the binding is complete. Note: To bind it quickly and effectively, please put the receiver 40-50cm away from the transmitter.

>**Failsafe.** Switch on the transmitter and receiver, then you can see the LED indicator on receiver is on. Adjust the throttle servo or ESC to brake or stop status, and keep it that way. Press the setup key, then receiver LED indicator flashes, keep this for 3 seconds. After this, release the setup key. Failsafe setup is complete.

>**Disabling failsafe function.** Switch on transmitter and receiver, once the signal is connected, LED indicator is on. Press the setup key for 2 seconds, LED indicator flashes quickly, at this point, keep pressing the setup key without release, press it for 2 more seconds, LED indicator flashes slowly. Release the setup key, LED indicator is on. The setup is complete.

## PART II:

### 2.4GHz Transmitter (LCD Version, Model#: D302HT)

#### Safety Precautions

Please refer to Safety Precautions in PART I

#### Transmitter Specifications

Please refer to Transmitter Specifications in PART I.

### 2.4GHz LCD Transmitter Parts and Functions

1. 2.4G transmitter antenna: before use, please pull the antenna straight up.
2. Power switch: Press down to turn on the transmitter, press the switch again to turn it off.
3. LCD display: shows transmitter menus, parameters and operation instructions.
4. Charging port: charging area is positive inside and negative outside. When Ni-Mh or Ni-Cd rechargeable batteries are to be charged, right charger should be selected for re-charging the batteries.
5. Throttle trigger: drag, push or make the throttle trigger to a neutral position to forward, reverse or brake your RC model.
6. Steering wheel: turn the steering wheel counterclockwise to turn the model to left. Turn the steering wheel clockwise to turn the model to right. Release it to neutral for straight driving.
7. Menu keys: Press Left key (<) or Right key (>), move the cursor to LCD display options.
8. DATA change keys: press Left key (+) or Right key (-) to change, adjust and save current parameters.
9. Throttle trigger set screw: use a 2.5mm hex screw driver to move forward or backward to adjust the throttle trigger to a comfortable hand feeling.
10. Battery compartment cover: Press the door to OPEN indicated direction to open the battery compartment cover. Snap the compartment door into the slot to close the battery compartment.
11. Installing batteries: open the battery compartment cover, install 4 pcs "AA" batteries (same type) according to the indicated "+" "-" orientations. Turn on the transmitter and check the indicator status for a solid green light. Please take out the batteries when the transmitter is not in use. If the status LED flashes red, the transmitter batteries may be weak, discharged or possibly installed incorrectly. Replace with new or freshly charged batteries. The power indicator light does not indicate the charge level of the battery pack installed in the model.

#### Parts Diagrams

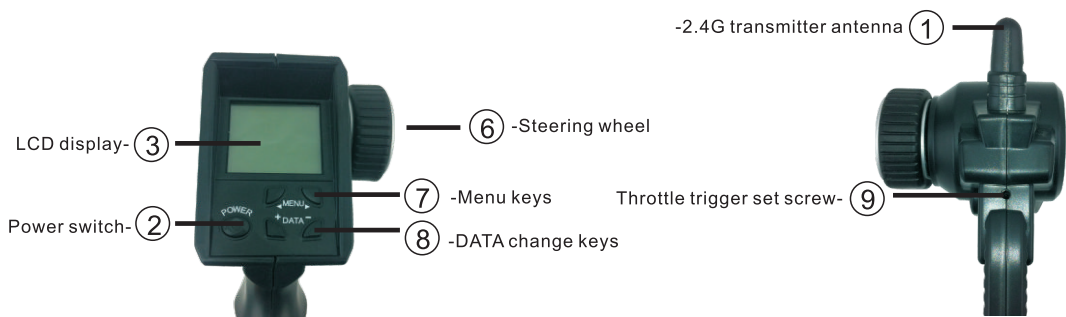

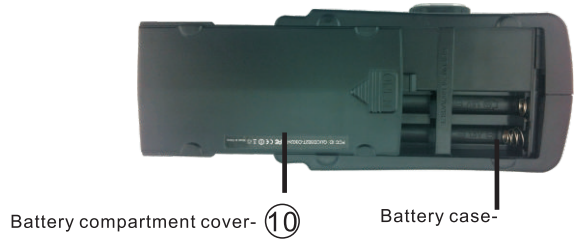

## LCD Functions and Operations

### Key Operations

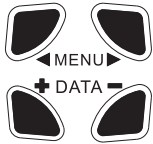

Menu keys:

Press Left key (<) to main command, and Right key (>) for secondary command.

DATA keys:

Press Left key (+) or Right key (-) to adjust, set up and auto save the current chosen function.

### Display Interface



Switch on the transmitter, you will hear “beep” sound (beeps once), and the LCD display mode will read the default parameters pre-set at the factory and BATT status mode (main menu).

### BATT: battery status, function reset settings

**Battery level display.** Battery voltage appears on LCD display. When the voltage is 4.4V, the value flashes and you can hear warning sound. This means the battery voltage is deficient. When battery voltage value shows 4.0V, the value blinks fast and warning sound keeps strong. This indicates battery voltage is too low and batteries cannot be used. Please turn off the transmitter and replace batteries. If rechargeable Ni-Mh or Ni-Cd batteries are used, please charge the batteries with proper charger.

**Function reposition.** In case the parameters are messed up or if you don't know how to set up, please turn off the power, press and hold MENU Left key (<). Then turn on the power and you will hear “beep” sound after two seconds. Release all keys and all parameters will go back to factory default values.

**Frequency duplication setting.** When two transmitters are used at the same time, a frequency might be duplicated. In this case, you may choose the auto frequency function. First turn off the power, then press and hold MENU Right key (>), and turn on the power. The display will show hopping data. Release the key and the hopping data will stop. The digit shown on the display is your frequency. Bind the transmitter with the receiver through binding keys.

### MOD: Setting up mode and naming

15 group memory data for choice, it's easy to manage and use. At start status, press Left key (+) or Right key (-) of the DATA to choose the necessary module (Screen shows main menu)

For easy control, you may name each module. Press Left key (<) on MENU (6 times on Main Menu) until you see 000 01 on the screen and the first digit must flash, at this moment, you may change the data here. Press Left key (+) or Right key (-) to choose necessary data. Once first change is made, press Right key (>) on MENU to move the cursor to the next position, then press Left key (-) or Right key (+) to choose the needed data. Based on the above, you can change data for the 3<sup>rd</sup> data group. Once all is changed, press Left key (<) on the MENU function to get back to Main Menu and save the setup. (Screen shows 000 01).

MOD	Range	Default
MODULE	0 – 15	01
NAMING UNITS	Digits 0-9, letters A-Z	000

## REV: Servo forward and reverse setup



**Setting up Steering servo direction.** Press MENU function Left key (<) or Right key (>) (Press once under MAIN MENU) until you see " \*\*\*REV-ST", then press DATA function Left key (+) or Right key (-) to choose ON/OFF. (Screen shows OFF REV-ST).



**Setting up Throttle speed neutral position.** Press MENU function Left key (<) (Press once under the MAIN MENU) and then press twice of MENU Right key (>) until you see \*\*\*REV-TH. Press DATA function Left key (+) or Right key (-) ON/OFF. (Screen shows OFF REV-TH).

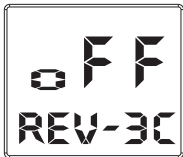

**Setting up the 3<sup>rd</sup> Channel:** Press MENU function Left key (<) (Press once under MAIN MENU), then press twice on Menu function Right key (>) until you see \*\*\*REV-3C, press DATA function Left key (+) or Right key (-) to choose ON/OFF. (Screen shows OFF REV-3C).

REV	Initial value	Range
ST	OFF	ON/OFF
TH	OFF	ON/OFF
3C	OFF	ON/OFF

## TRM: Servo neutral trim setup

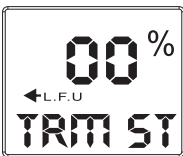

**Setting up steering servo(ST) neutral position parameters.** Press MENU function Left key (<) (Press twice under MAIN MENU) until you see \*\*% TRM ST and neutral value. Press DATA function Left key (+) or Right key (-) to change the steering neutral position. On the screen there is steering neutral status L.F. U, R. B. D and percentage values indicating the neutral position at that setup. (Screen shows 00% TRM ST).

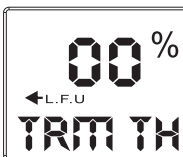

**Setting up throttle speed (TH) neutral position parameters.** Press MENU function Left key (<) (Press twice under MAIN MENU), and press MENU function Right key (<) until you see \*\*% TRM TH and neutral value. At this point, press DATA function Left key (+) or Right key (-) for adjustment. On the screen you will see neutral position status indicator L. F. U, R. B. D and percentage values. (Screen shows 00% TRM TH)

TRM	Initial value	Range
ST	0%	100%<--L. F. U—100% R.B.D.-->
TH	0%	100%<--L. F. U—100% R.B.D.-->

## D/R: Servo angle adjustment setup



**Set up Steering servo (ST) angle.** Press Menu function Left key (<) (Press 3 times on MAIN MENU) until you see \*\*% D/R ST on the screen, then press DATA function Left key (+) or Right key (-) to choose servo angle parameter. (Screen shows 100% D/R ST).

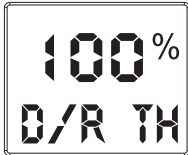

**Set up Throttle servo (TH) forward and reverse angle.** Press MENU function Left key (<) (Press 3 times on MAIN MENU), then press MENU function Right key (>) once, the screen shows \*\*% D/R TH, press DATA function Left key (+) or Right key (-) for throttle angle parameters. (Screen shows 100% D/R TH)

D/R	Initial value	Range
ST	100%	0% - 100%
TH	100%	0% - 100%

## EPA: End point adjustment (servo single side angle setup)

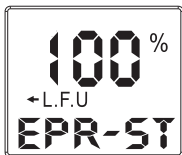

**Set up steering servo single side (left steering or right steering) travel angle.** Press MENU function Left key (<) (Press 4 times under MAIN MENU) until the screen shows \*\*% EPA ST. Turn the steering wheel clockwise, the screen shows the EPA value of right steering R.B.D.-->; Press DATA function Left key (+) or Right key (-) and change the data. When you turn the steering wheel counterclockwise, the screen displays the EPA value of left steering L. F. U on steering servo. Press DATA function Left key (+) or Right key (-) for desired value. (Screen shows 100% EPA-ST)



Note: for this function, the steering servo travel angle is adjusted to a wider or narrower range, hence the steering angle of the left or right tire is adjusted to desired angle.

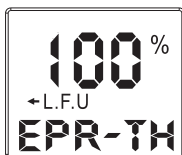

**Set up throttle speed (forward or reverse).** Press MENU function Left key (<) (Press 4 times under MAIN MENU) and press once on MENU function Right key (>), the screen shows \*\*% EPA TH. Pull back the throttle trigger and the screen displays L.F.U value of forward (F) speed. Press DATA function Left key (+) or Right key (-) to change the value. Push forward the throttle trigger and the screen shows reverse R.B.D value of reverse speed, press DATA function Left key (+) or Right key (-) to change the value. (Screen shows 100% EPA-ST)



Note: for this function, the throttle servo angle is adjusted (wider or narrower) on nitro- (gas-) powered vehicles, and for EP vehicles, speed of the electronic speed controller adjusted (faster or slower).

EPA	Initial value	Range
ST←L.F.U	100%	0% - 120%
ST R.B.D→	100%	0% - 120%
TH←L.F.U	100%	0% - 120%
TH R.B.D→	100%	0% - 120%



## ABS: Setting up brake system



**Set up throttle ABS brake system.** Press MENU function Left key (<) (Press 5 times under MAIN MENU), screen shows \*\*\* ABS- TH, press DATA function Left key (+) or Right key (-) to choose ON/OFF. At ON status, it prevents the tires from getting stuck in powerful gripping motion during brake. (Screen shows \*\*\* ABS- TH)

For each of the above setup, when one setting is selected, please wait for 5 seconds until you see the main menu, then that setting is automatically saved as memory.

## Receiver Functions

Please refer to Receiver Functions Section in PART I.

FCC Caution: Any changes or modifications not expressly approved by the party responsible for compliance could void the user's authority to operate this equipment. This device complies with Part 15 of the FCC Rules. Operation is subject to two conditions: (1) This device may not cause harmful interference, and (2) This device must accept any interference received, including interference that may cause undesired operation.

This device and its antenna(s) must not be co-located or operating in conjunction with any other antenna or transmitter.



Shenzhen Bontek Electronic Technology Co., Ltd.

## CE Attestation of Conformity

Certification number: BCT11GC-1068E

Report number: BCT11GR-1068E-1, BCT11GR-1068E-2

**Shenzhen Bontek Electronic Technology Co., Ltd. hereby declares that testing has been completed and reports have been generated for:**

**Applicant: DHK TECHNOLOGY CO. LTD.**

E2 Bldg, Wanfeng Western Ind Zone, Heyi, Shajing, Shenzhen, China  
518104

**Manufacturer: DHK TECHNOLOGY CO. LTD.**

E2 Bldg, Wanfeng Western Ind Zone, Heyi, Shajing, Shenzhen, China  
518104

**Trade Mark: DHK HOBBY**

**Product: 2.4GHz Transmitter & Receiver**

**Model: D302T, D302HT**

And, in accordance to the following applicable directives:

**1999/5/EC R&TTE Directive (as amended)**

That this product has been assessed against the following applicable Standards;

**R&TTE**  
ETSI EN 300 440-1 V1.6.1  
ETSI EN 300 440-2 V1.4.1  
ETSI EN 301 489-1 V1.8.1  
ETSI EN 301 489-3 V1.4.1

Therefore, SHENZHEN BONTEK ELECTRONIC TECHNOLOGY CO., LTD. hereby acknowledges that the Manufacturer may issue a DECLARATION of CONFORMITY and apply the CE mark in accordance to European Union Rules.

Attestation by:

Kendy Wang



Date of Issued: Sep. 5, 2011

1/F, Block East H-3, OCT Eastern Ind. Zone, Qiaocheng East Road, Nanshan, Shenzhen, China

Tel:+86-755-86337020 Fax:86-755-86337028 <http://www.bontek.com.cn>

TCB

GRANT OF EQUIPMENT  
AUTHORIZATION

TCB

Certification  
Issued Under the Authority of the  
Federal Communications Commission  
By:

PHOENIX TESTLAB GmbH  
Koenigswinkel 10  
D-32825 Blomberg,  
Germany

Date of Grant: 11/20/2012  
Application Dated: 11/20/2012

DHK TECHNOLOGY CO., LTD.  
E2 BLDG, WANFENG WESTERN IND ZONE, HEYI, SHAJING  
SHENZHEN, 518104  
China

Attention: Jack Jiang , Manger

NOT TRANSFERABLE

EQUIPMENT AUTHORIZATION IS HEREBY ISSUED TO THE NAMED GRANTEE, AND IS  
VALID ONLY FOR THE EQUIPMENT IDENTIFIED HEREON FOR USE UNDER THE COMMISSION'S  
RULES AND REGULATIONS LISTED BELOW.

FCC IDENTIFIER: QUCD302T-D302HT  
Name of Grantee: DHK TECHNOLOGY CO., LTD.  
Equipment Class: Part 15 Low Power Communication Device  
Transmitter  
Notes: 2.4GHz Transmitter

Grant Notes

FCC Rule Parts

15C

Frequency  
Range (MHZ)  
2402.0 - 2474.0

Output  
Watts

Frequency  
Tolerance

Emission  
Designator

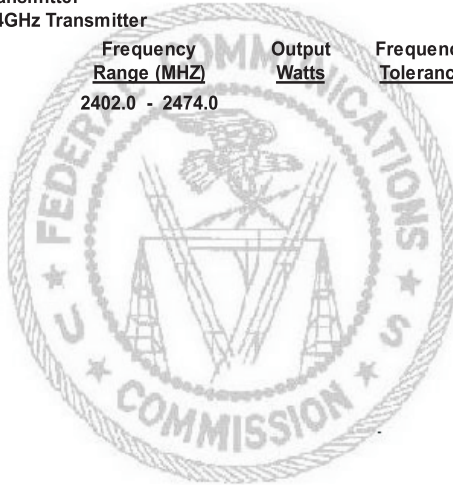

**DHK TECHNOLOGY CO.LTD**  
<http://www.dkhobby.com>

